

# Unità Centrale Central Unit

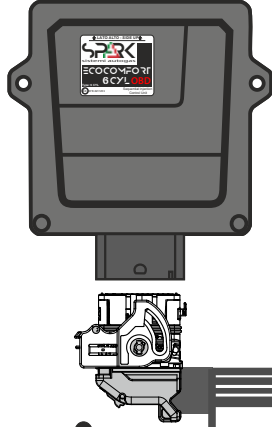

Montare la centralina con  
connettore verso il basso  
Place central unit with  
connector down

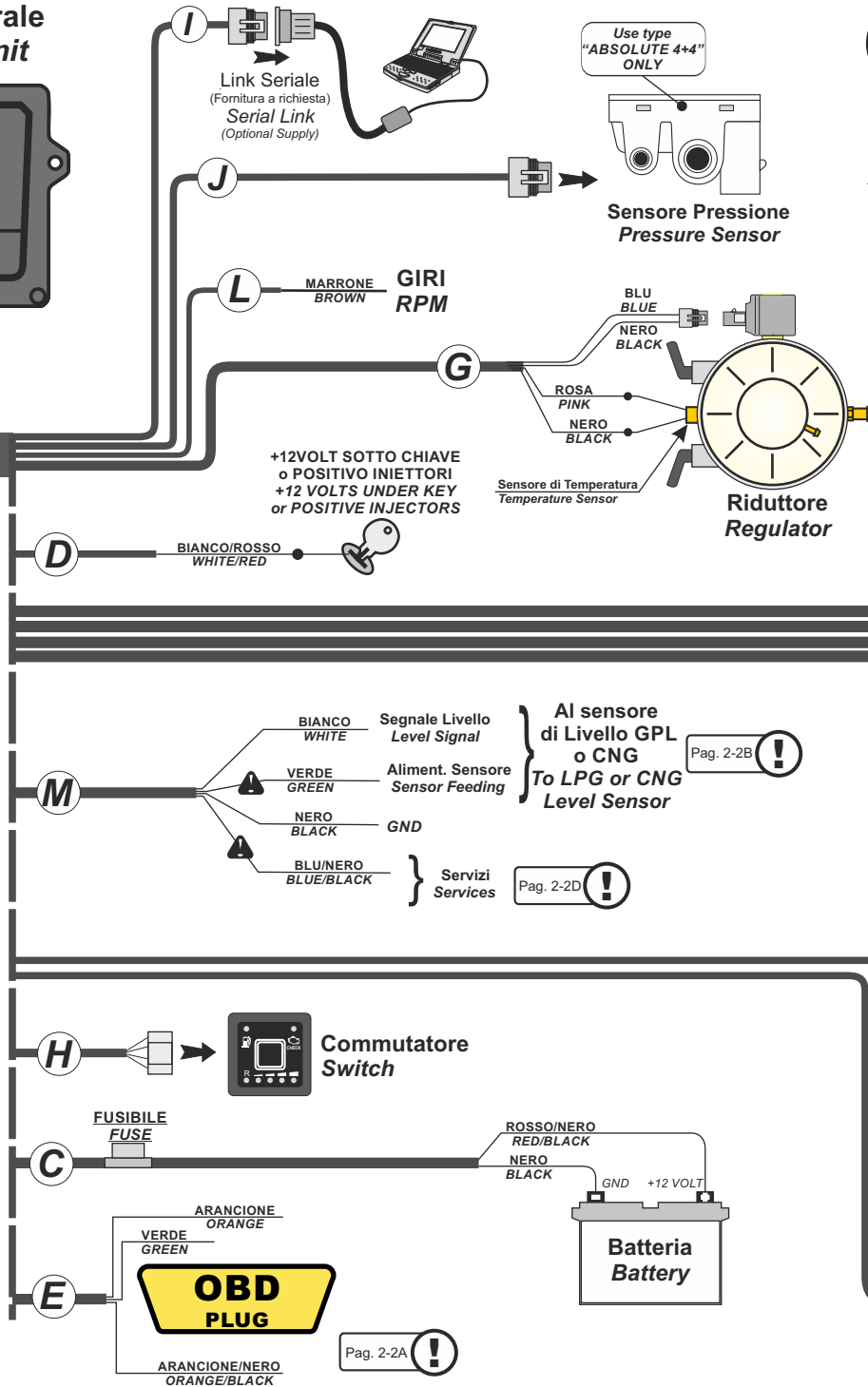

# SPARK

sistemi autogas

## Sequential Injection (6C) Schema Elettrico - Electric Wiring COCOMFORT 6CYL OBD

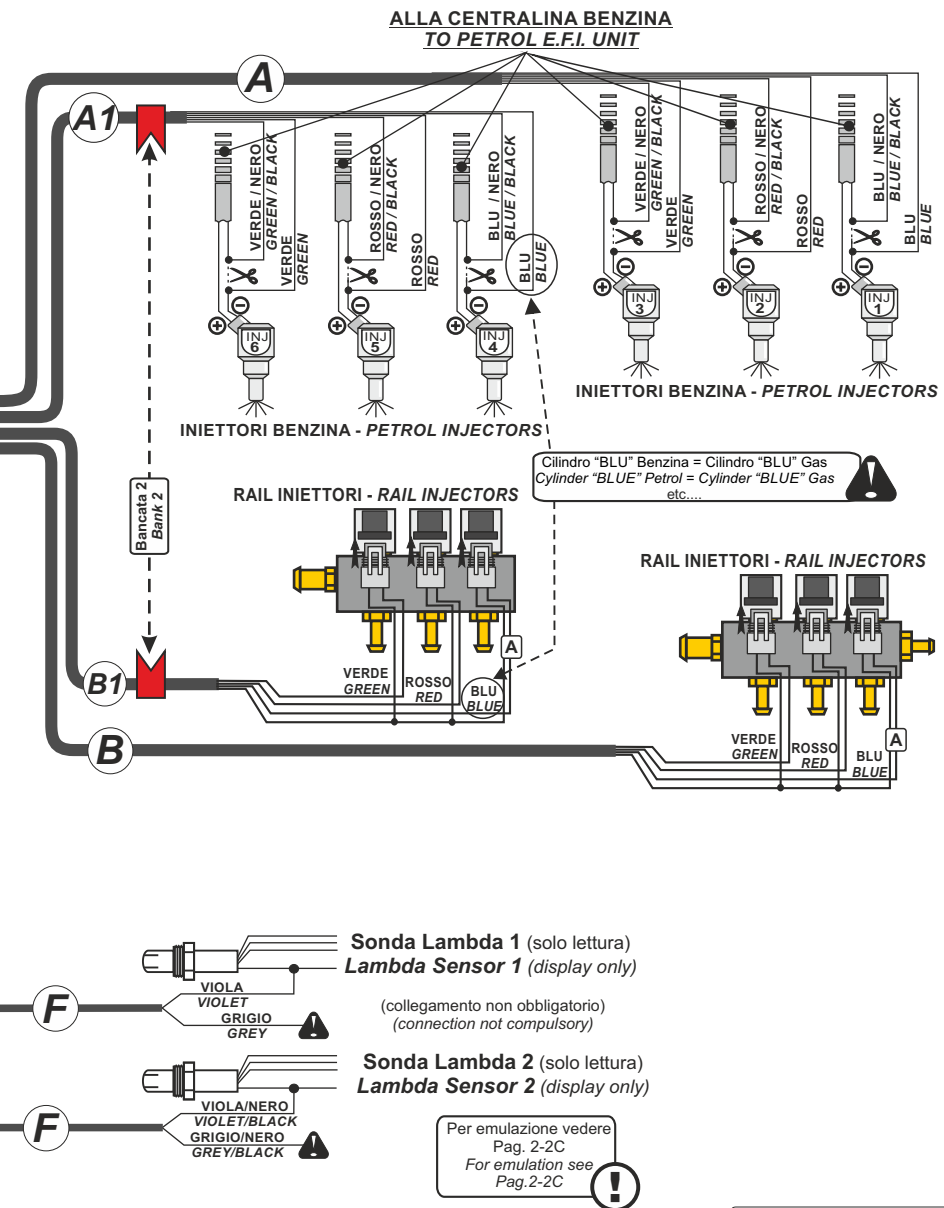

**COLLEGAMENTO PRESA OBD** (collegamento non obbligatorio).  
**CONNECTION TO OBD PLUG** (connection not compulsory)

**2 - A**

**CAN**

COLORE COLOR	PIN
ARANCIONE/ ORANGE	6
ARANCIONE/NERO ORANGE/BLACK	14

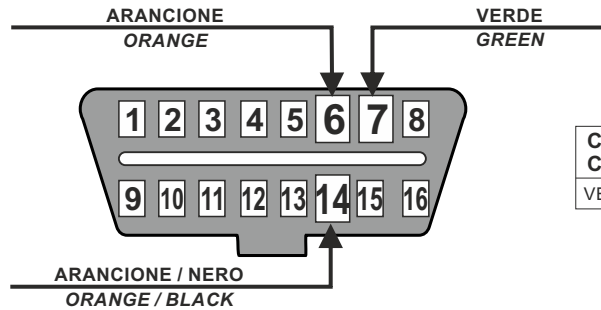

**ISO**

COLORE COLOR	PIN
VERDE/GREEN	7

(VISTA FRONTALE CONNETTORE OBD VEICOLO)  
 (FRONT VIEW OBD VEHICLE CONNECTOR)

⚠ Se non si collega presa OBD la centralina gas lavora come normale centralina non OBD  
 If you not connect the OBD plug, the ECU works as a system not OBD

⚠ N.B. lasciare isolati i cavi in caso di mancanza del contatto nel connettore OBD veicolo  
 N.B. In case some contacts in the OBD connector are not present, keep the relevant cables insulated

**SCHEMI DI COLLEGAMENTO SENSORI DI LIVELLO**  
**LEVEL SENSORS WIRING DIAGRAM**

**2 - B**

**SENSORE LIVELLO GPL 0..90 OHM**  
**0..90 OHM LPG LEVEL SENSOR**

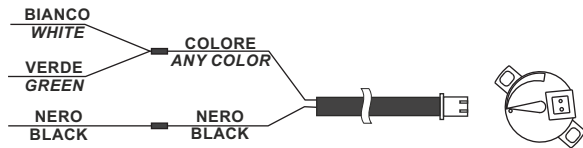

**SENSORE Tipo 806 (Metano)**  
**CNG SENSOR Type 806**

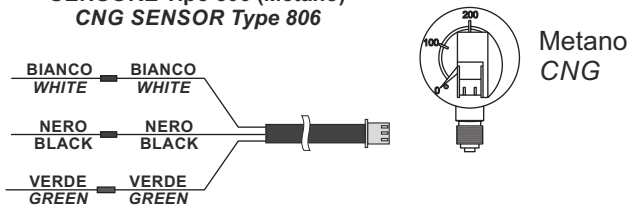

**SENSORE Tipo 1050 (GPL)**  
**LPG SENSOR Type 1050**

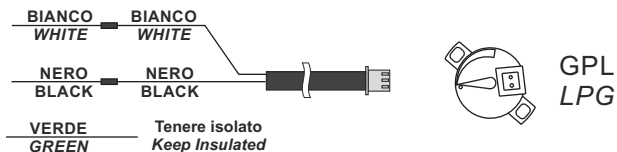

**SCHEMA COLLEGAMENTO SONDA LAMBDA - EMULAZIONE**  
**WIRING DIAGRAM FOR LAMBDA SENSOR - EMULATION**

**2 - C**

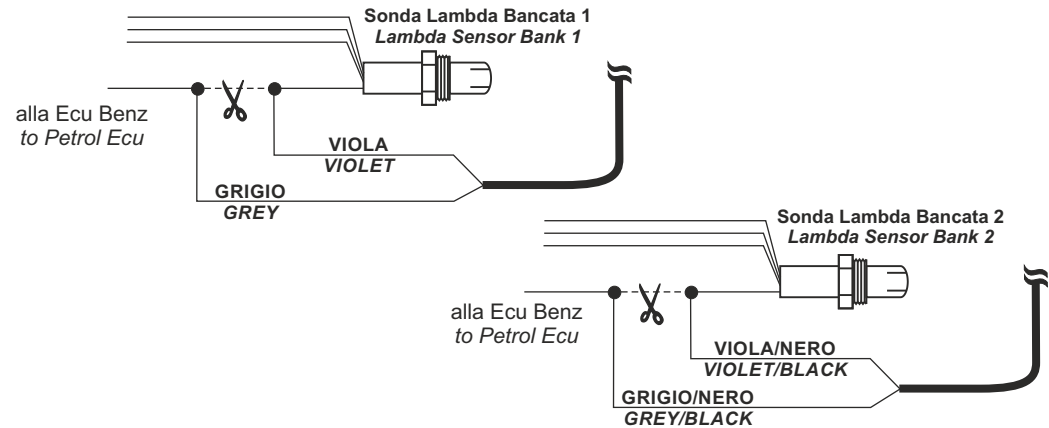

**SCHEMA COLLEGAMENTO SERVIZI**  
**SERVICES WIRING DIAGRAM**

**2 - D**

⚠ Possibili connessioni; da selezionare nel software  
 Possible connections; select in the software

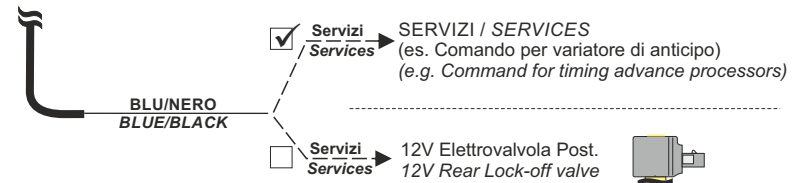

**COLLEGAMENTO SENSORE PRESSIONE - PRESSURE SENSOR INSTALLATION**

