

Unità Centrale
Central Unit

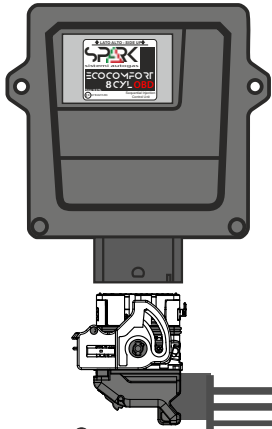

Montare la centralina con connettore verso il basso
Place central unit with connector down

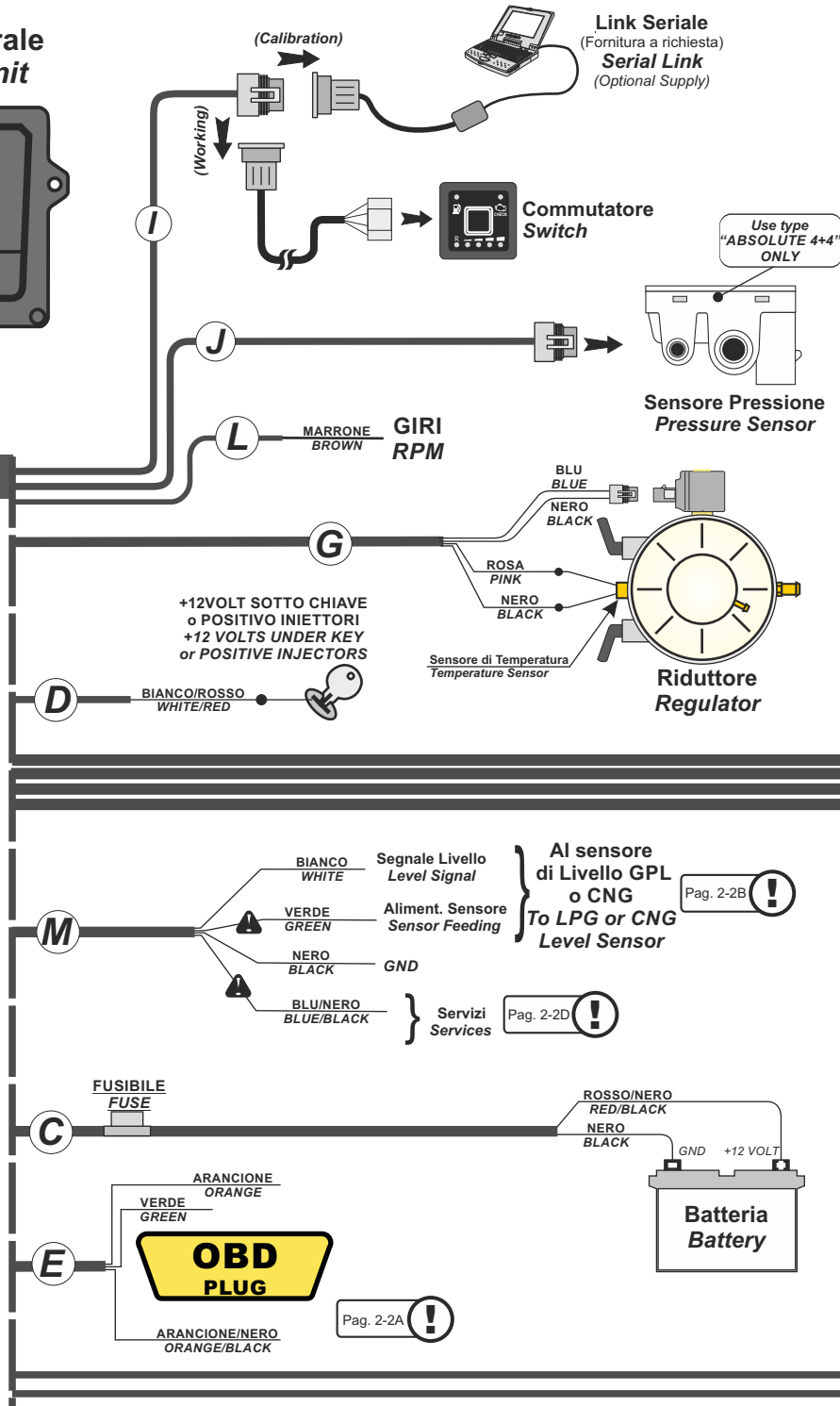

SPARK
sistemi autogas

Sequential Injection **8C**
Schema Elettrico - Electric Wiring
COCOMO
8 CYL OBD

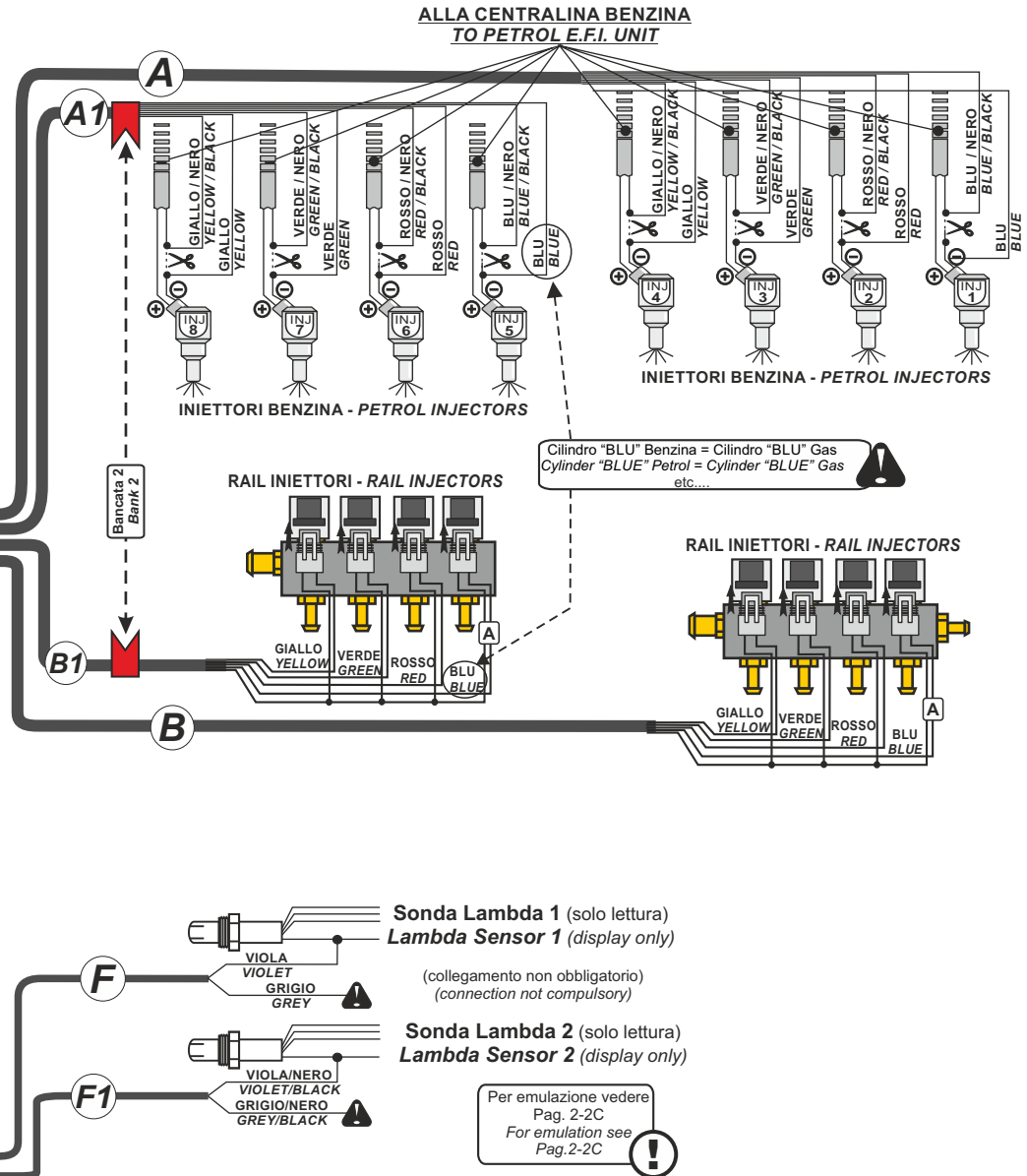

COLLEGAMENTO PRESA OBD (collegamento non obbligatorio).
CONNECTION TO OBD PLUG (connection not compulsory)

2 - A

CAN

COLORE COLOR	PIN
ARANCIONE/ ORANGE	6
ARANCIONE/NERO ORANGE/BLACK	14

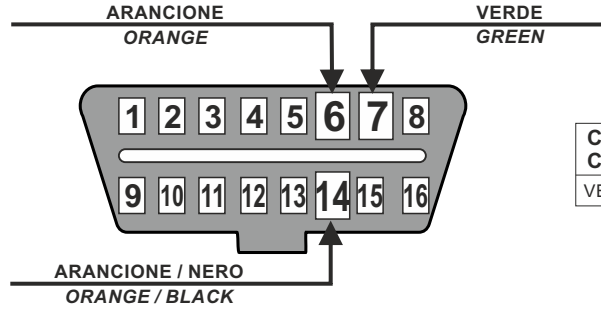

ISO

COLORE COLOR	PIN
VERDE/GREEN	7

(VISTA FRONTALE CONNETTORE OBD VEICOLO)
 (FRONT VIEW OBD VEHICLE CONNECTOR)

⚠ Se non si collega presa OBD la centralina gas lavora come normale centralina non OBD
 If you not connect the ODB plug, the ECU works as a system not OBD

⚠ N.B. lasciare isolati i cavi in caso di mancanza del contatto nel connettore OBD veicolo
 N.B. In case some contacts in the OBD connector are not present, keep the relevant cables insulated

SCHEMI DI COLLEGAMENTO SENSORI DI LIVELLO
LEVEL SENSORS WIRING DIAGRAM

2 - B

SENSORE LIVELLO GPL 0..90 OHM
0..90 OHM LPG LEVEL SENSOR

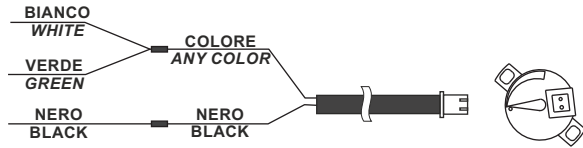

SENSORE Tipo 806 (Metano)
CNG SENSOR Type 806

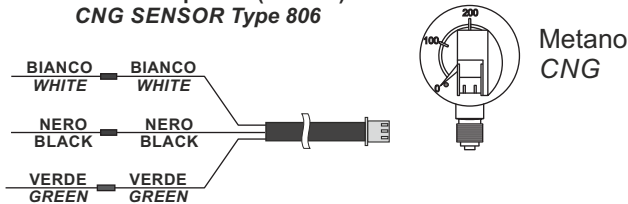

SENSORE Tipo 1050 (GPL)
LPG SENSOR Type 1050

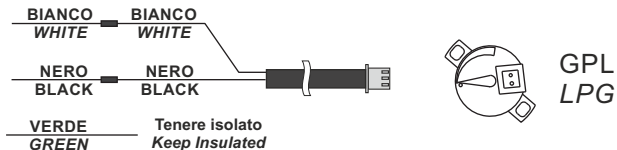

SCHEMA COLLEGAMENTO SONDA LAMBDA - EMULAZIONE
WIRING DIAGRAM FOR LAMBDA SENSOR - EMULATION

2 - C

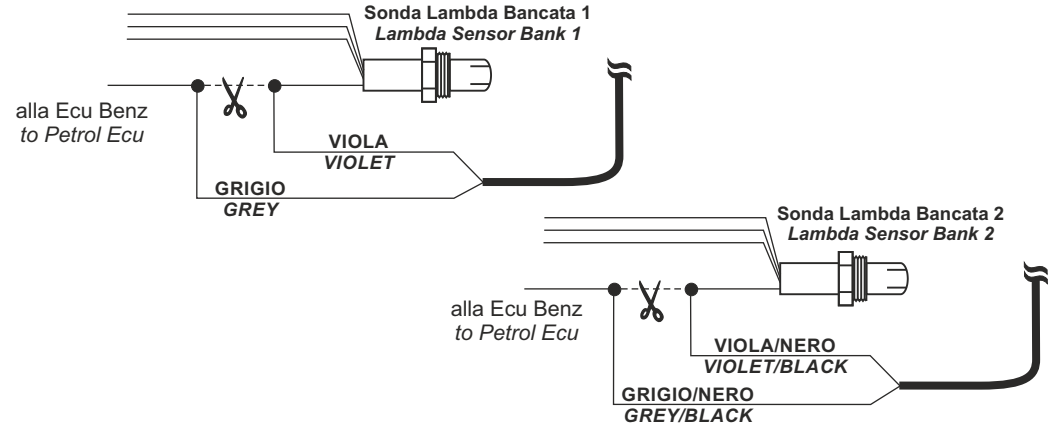

SCHEMA COLLEGAMENTO SERVIZI
SERVICES WIRING DIAGRAM

2 - D

⚠ Possibili connessioni; da selezionare nel software
 Possible connections; select in the software

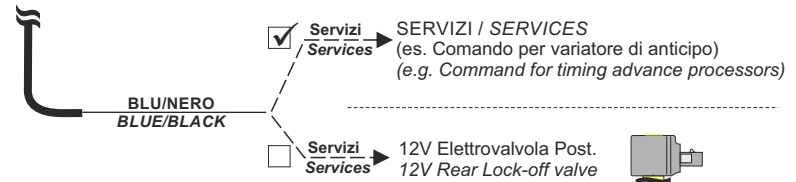

COLLEGAMENTO SENSORE PRESSIONE
PRESSURE SENSOR INSTALLATION

⚠ Montare lontano da fonti di calore (motore, catalizzatore, ecc...)
 Install away from heat sources (engine, catalyzer, etc...)

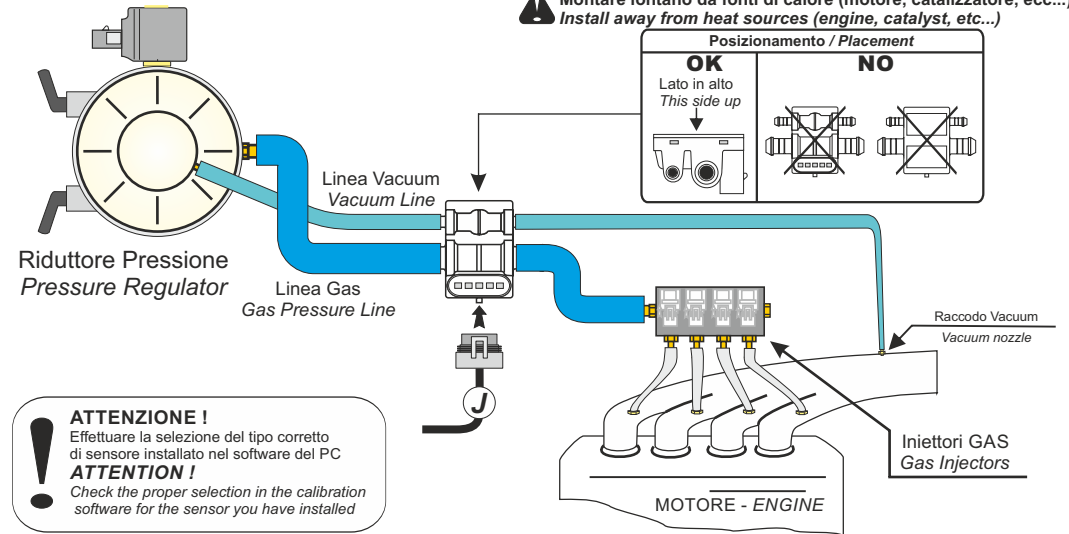

⚠ **ATTENZIONE !**
 Effettuare la selezione del tipo corretto di sensore installato nel software del PC
ATTENTION !
 Check the proper selection in the calibration software for the sensor you have installed